



**Juntalima**  
Indústria e Comércio de Auto Peças Ltda

**PEUGEOT  
CITROEN**



Motor/Engine 1.1 / 1.3 / 1.4 8V

Códigos jogos de juntas  
Code set gaskets

TU1/TU1M - TU2.4 - TU3

Modelo / Model	Cm³	De	Até
205	1124	1987	1996
309	1124	1990	1993
106	1124	1991	
306	1124	1993	1997
205 Rallye	1294	1988	1993
405	1360	1987	1994
205	1360	1987	1996
309	1360	1988	1993
106	1360	1991	
306	1360	1993	
Partner	1360	1996	
206	1360	1998	
ZX	1124	1991	1997
C15	1124	1988	
AX Sport	1294	1987	1991
ZX	1360	1991	1998
C15	1360	1988	

Completo com retentores  
**57700CR**  
Completo sem retentores  
**57700C**  
Kit retificação com retentores  
**57700KR**  
Kit retificação sem retentores  
**57700K**

Full set with oil seals  
**57700CR**  
Full set without oil seals  
**57700C**  
Retification kit with seals  
**57700KR**  
Retification kit without seals  
**57700K**

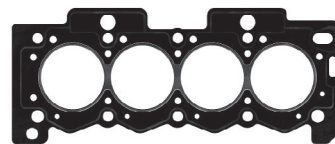

JL57707

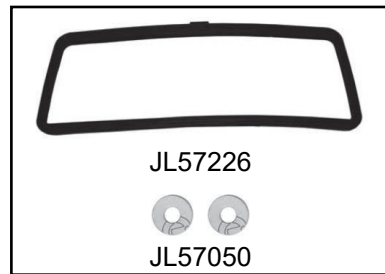

JL57226

JL57050

JL57226K



JL57045



JL57817



JL57216



JL57721



JL57044



JL57445



JL57047 (x2)

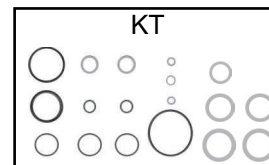

KT

Código/Code	N° Original	Aplicação / application	MP	C	K	M
57707		Cabeçote / cylinder head gasket	PAK	1	1	
57226		Tampa de válvulas / rocker cover gasket	BO	1	1	
57050		Termostato / thermostat	NA	2	2	
57226K		Kit tampa de válvulas / rocker cover set	KT			
57045		Coletor de admissão / intake manifold	NA	2	2	
57817		Coletor de escapamento / exhaust manifold	PAK	2	2	
57216		Cárter / oil pan	NA	1		
57721		Saída do escapamento / exhaust pipe	CNAC	1	1	
57044		Base do carburador / Base carburetor	NA	1	1	
57445		Alojamento termostato	NA	1	1	
57047		Guarnição / garrison	NA	2	2	
KT		Kit de borrachas e arruelas / rubbers and washers	KT	1	1	
R950004		Kit de retentores para motor completo				
R921001	7581344	Retentores de haste de válvulas	VI	8	8	
R954002	2101-1107015	Retentor do comando de válvulas 36x50x7	SI	1	1	
R953002	51474	Retentor traseiro do virabrequim 85x105x12	SI	1		
R954003	51472	Retentor dianteiro do virabrequim 42x66x6	SI	1		

Itens Relacionados

Juntas para Injeção Eletrônica

Juntas para Injeção Eletrônica

Juntas para Filtro de Óleo

Juntas para Filtro de Óleo

JL15550  
Jogo de juntas para I.E. Peugeot 405/206 Singlepoint

JL15551  
Jogo de juntas para I.E. Peugeot 205 X SI 1.4 Singlepoint

JL57153  
Kit Borracha Base Filtro Óleo Peugeot 207/307/308 Motor 1.4/ 1.6

JL57154  
Kit Borracha Base Óleo Peugeot 206/207 Citroën C3/ Picasso Motor 1.4/ 1.6 16V 2006

Em breve novidades

R950004  
R921001 R954002  
R953002 R954003



Motor/Engine 1.2 12V EB2D / EB2F  
HMT - HMU - HMZ

Códigos jogos de juntas  
Code set gaskets

Modelo / Model	Cm³	De	Até
208	1199	2012	
2008	1199	2013	
308 II	1199	2013	
108	1199	2014	
C3 II	1199	2012	
DS3	1199	2013	2015
DS3 Cabriolet	1199	2013	2015
C1 II	1199	2014	
C4 Cactus	1199	2014	

Completo sem retentor flange <b>57109CRSF</b>	Full set without Flange oil seals <b>57109CRSF</b>
Completo MLS sem flange <b>57109CMRSF</b>	Full set MLS w/o Flange oil seals <b>57109CMRSF</b>
Completo com retentores <b>57109CR</b>	Full set with oil seals <b>57109CR</b>
Completo sem retentores <b>57109C</b>	Full set without oil seals <b>57109C</b>
Completo MLS com retentores <b>57109CMR</b>	Full set MLS with oil seals <b>57109CMR</b>
Completo MLS sem retentores <b>57109CM</b>	Full set MLS without oil seals <b>57109CM</b>
Kit retificação com retentores <b>57109KR</b>	Head set with oil seals <b>57109KR</b>
Kit retificação sem retentores <b>57109K</b>	Head set without oil seals <b>57109K</b>
Kit retificação MLS com retentores <b>57109KMR</b>	MLS Head set with oil seals <b>57109KMR</b>
Kit retificação MLS sem retentores <b>57109KM</b>	MLS Head set without oil seals <b>57109KM</b>

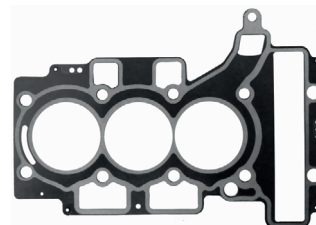

JL57109

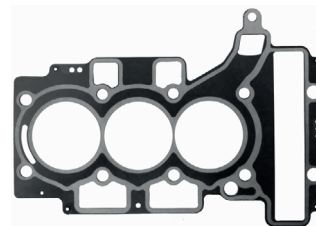

JL57109MLS

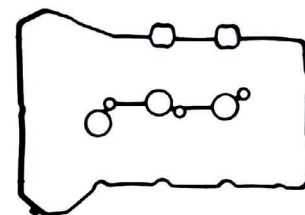

JL57027K



JL57032K



JL57033



JL57020



JL57055



JL57058



JL57059



JLKA023

Código/Code	N° Original	Aplicação / application	MP	C	K	M
57109	96.761.486.80	Cabeçote / cylinder head gasket	PAK	1	1	
57109MLS	96.761.486.80	Cabeçote / cylinder head gasket	MLS			1
57027K		Kit tampa de válvulas / rocker cover gasket	KIT	1	1	1
57032K		Kit coletor de admissão / intake manifold	KIT	1	1	1
57033	96.880.312.80	Saída de escapamento / exhaust pipe	CNAC	1	1	1
57020		Bomba d'água / water pump	NA	1	1	1
57055	96.762.317.80	Placa do fechamento do bloco	BO	1		1
57058		Bomba d'água / water pump	BO	1		1
57059		Termostato / thermostat	BO	1		1
KA023		Kit de arruelas / kit washers	KA	1	1	1
R950009		Kit de retentores para motor com flange				
R950010		Kit de retentores para motor sem flange				
R951005		Retentores de haste de válvulas	VI	12	12	12
R954007		Retentor dianteiro do virabrequim 61x75x8	SI	1		1
R952001		Retentor traseiro flange	PTFE	1		1

Itens Relacionados

Juntas para  
Cárter



Em breve  
novidades

Em breve  
novidades

Em breve  
novidades

Em breve  
novidades

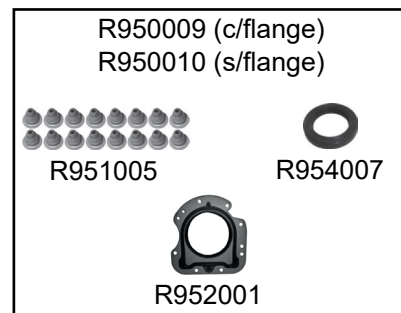



Motor/Engine 1.4 8V TU3JP (KFW/K6D/KFV)

Códigos jogos de juntas  
Code set gaskets

Modelo / Model	Cm³	De	Até	Completo com retentores <b>57101CR</b>	Full set with oil seals <b>57101CR</b>
206	1360	2001		Completo sem retentores <b>57101C</b>	Full set without oil seals <b>57101C</b>
307	1360	2001		Kit retificação com retentores <b>57101KR</b>	Retification kit with seals <b>57101KR</b>
C3	1360	2002		Kit retificação sem retentores <b>57101K</b>	Retification kit without seals <b>57101K</b>
C2	1360	2002			
C3 Pluriel	1360	2002			

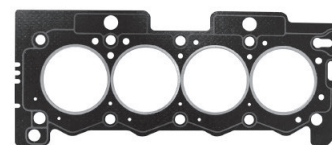

JL57802

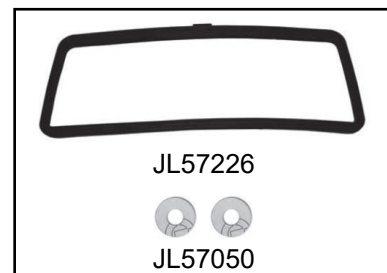

JL57226

JL57050

JL57226K



JL57922

JL57924



JL57921



JL57216

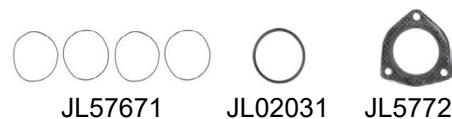

JL57671

JL02031

JL57721

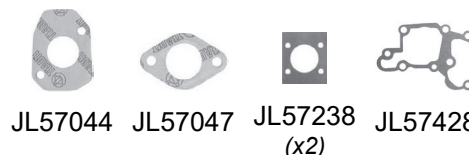

JL57044

JL57047

JL57238

JL57428

(x2)



JL57240

JL57125

JL57445

JL57438

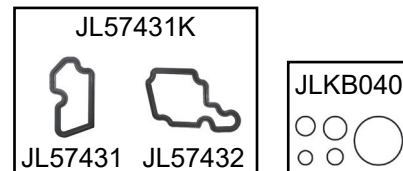

JL57431K

JL57431

JL57432

JLKB040

Código/Code	N° Original	Aplicação / application	MP	C	K	M
57802		Cabeçote / cylinder head gasket	PAK	1	1	
57226		Tampa de válvulas / rocker cover gasket	BO	1	1	
57050		Termostato / thermostat	NA	2	2	
57226K		Kit tampa de válvulas / rocker cover set	KT			
57922		Coletor de admissão / intake manifold	SI	1	1	
57924		Coletor de admissão / intake manifold	BO	1	1	
57921		Coletor de escapamento / exhaust manifold	CNAC	1	1	
57216		Cárter / oil pan	NA	1		
57671		Camisa do cilindro	SI	4	4	
02031		Anel de vedação	BO	1	1	
57721		Saída do escapamento / exhaust pipe	CNAC	1	1	
57044		Base do carburador / Base carburetor	NA	1	1	
57047		Guarnição	NA	1		
57238		Guarnição	PP	2		
57428		Válvula termostática	GV	1	1	
57240		Guarnição / garrison	CNAC	1		
57125		Saída escapamento / exhaust pipe	CNAC	1		
57445		Alojamento termostato	NA	1	1	
57438		Anel de vedação	BO	1	1	
57431		Válvula termostática	BO			
57432		Válvula termostática	BO			
57431K		Kit válvula termostática	KIT	1	1	
KB040		Kit de borrachas / rubbers set	KB	1	1	
R950004		Kit de retentores para motor completo	KIT			
R921001	7581344	Retentores de haste de válvulas	VI	8	8	
R954002	2101-1107015	Retentor do comando de válvulas 36x50x7	SI	1	1	
R953002	51474	Retentor traseiro do virabrequim 85x105x12	SI	1		
R954003	51472	Retentor dianteiro do virabrequim 42x66x6	SI	1		

Itens Relacionados

Juntas para Injeção Eletrônica

Juntas para Injeção Eletrônica

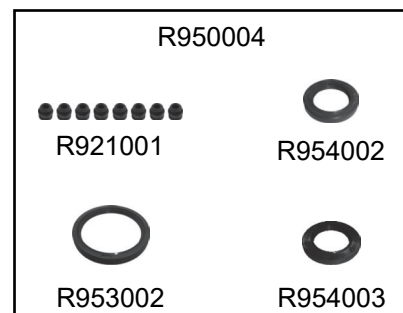
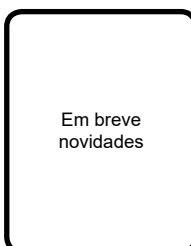
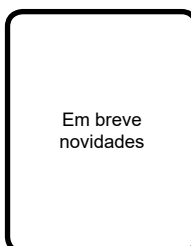
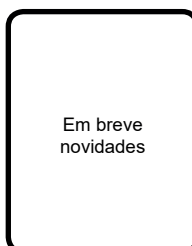
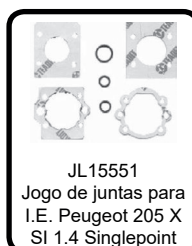



Motor/Engine 1.5 8V TU4M

Códigos jogos de juntas  
Code set gaskets

Modelo / Model	Cm³	De	Até	Completo com retentores <b>57301CR</b>	Full set with oil seals <b>57301CR</b>
208	1500	2012		Completo sem retentores <b>57301C</b>	Full set without oil seals <b>57301C</b>
C3	1500	2012		Completo MLS com retentores <b>57301CMR</b>	Full set MLS with oil seals <b>57301CMR</b>
				Completo MLS sem retentores <b>57301CM</b>	Full set MLS without oil seals <b>57301CM</b>
				Kit retificação com retentores <b>57301KR</b>	Head set with oil seals <b>57301KR</b>
				Kit retificação sem retentores <b>57301K</b>	Head set without oil seals <b>57301K</b>
				Kit retificação MLS com retentores <b>57301KMR</b>	MLS Head set with oil seals <b>57301KMR</b>
				Kit retificação MLS sem retentores <b>57301KM</b>	MLS Head set without oil seals <b>57301KM</b>

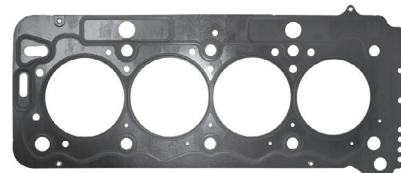

JL57301

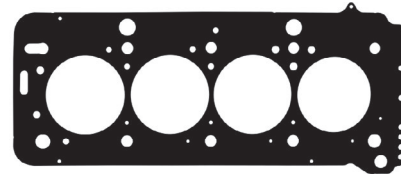

JL57301MLS

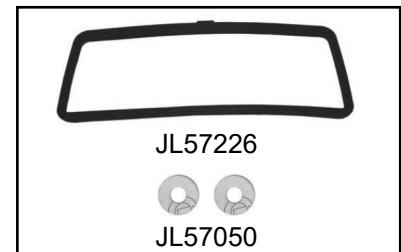

JL57226

JL57050

JL57226K

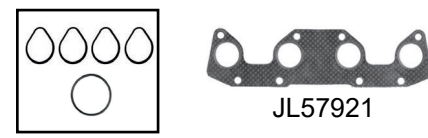

JL57921

JL57932K

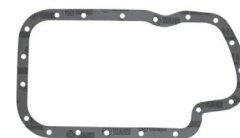

JL57216

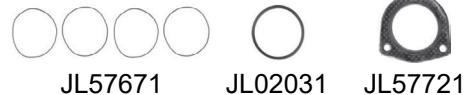

JL57671

JL02031

JL57721



JL57044

JL57047

JL57238

JL57428

(x2)



JL57431

JL57432

JL57240

JL57125

JL57431K

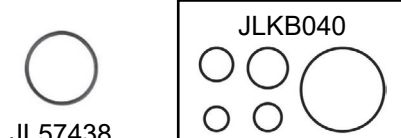

JL57438

JLKB040

R950012



R911002



R954002



R953002



R954003

Código/Code	N° Original	Aplicação / application	MP	C	K	M
57301	9675654080	Cabeçote / cylinder head gasket	PAK	1	1	
57301MLS	9675654080	Cabeçote / cylinder head gasket	MLS			1
57226		Tampa de válvulas / rocker cover gasket	BO	1	1	1
57050		Termostato / thermostat	NA	2	2	2
57226K		Kit tampa de válvulas / rocker cover set	KT			
57932K		Coletor de admissão / intake manifold - Borracha	KT	1	1	1
57921		Coletor de escapamento / exhaust manifold	CNAC	1	1	1
57216		Cárter / oil pan	NA	1		1
57671		Camisa do cilindro	SI	4	4	4
02031		Anel de vedação	BO	1	1	1
57721		Saída do escapamento / exhaust pipe	CNAC	1	1	1
57044		Base do carburador / carburetor base	NA	1	1	1
57047		Guarnição	NA	1		1
57238		Guarnição	PP	2		2
57428		Válvula termostática	GV	1	1	1
57431		Válvula termostática	BO			
57432		Válvula termostática	BO			
57431K		Kit válvula termostática de borracha	KIT	1	1	1
57240		Guarnição	CNAC	1		1
57125		Saída escapamento / exhaust pipe	CNAC	1		1
57438		Anel de vedação	BO	1	1	1
KB040		Kit de borrachas / rubbers set	KB	1	1	1
R950012		Kit de retentores para motor completo	KIT			
R911002	7581344	Retentores de haste de válvulas	VI	8	8	8
R954002	2101-1107015	Retentor do comando de válvulas 36x50x7	SI	1	1	1
R953002	51474	Retentor traseiro do virabrequim 85x105x12	SI	1		1
R954003	51472	Retentor dianteiro do virabrequim 42x66x6	SI	1		1

Itens Relacionados

Juntas para Injeção Eletrônica

Juntas para Injeção Eletrônica

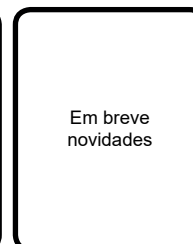
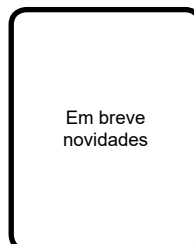
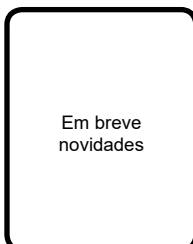
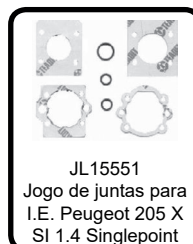



Motor/Engine 1.6 8V TU5JP / TU5J2

Códigos jogos de juntas  
Code set gaskets

Modelo / Model	Cm³	De	Até	Completo com retentores <b>57308CR</b>	Full set with oil seals <b>57308CR</b>
106	1587	1994		Completo sem retentores <b>57308C</b>	Full set without oil seals <b>57308C</b>
206	1587	1998		Completo MLS com retentores <b>57308CMR</b>	Full set MLS with oil seals <b>57308CMR</b>
306	1587	1993		Completo MLS sem retentores <b>57308CM</b>	Full set MLS without oil seals <b>57308CM</b>
Xsara Picasso	1587	2000		Kit retificação com retentores <b>57308KR</b>	Head set with oil seals <b>57308KR</b>
				Kit retificação sem retentores <b>57308K</b>	Head set without oil seals <b>57308K</b>
				Kit retificação MLS com retentores <b>57308KMR</b>	MLS Head set with oil seals <b>57308KMR</b>
				Kit retificação MLS sem retentores <b>57308KM</b>	MLS Head set without oil seals <b>57308KM</b>

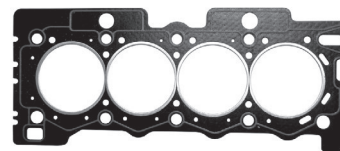

JL57308

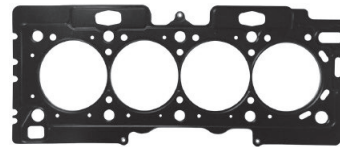

JL57308MLS

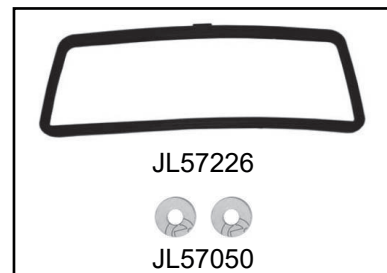

JL57226

JL57050

JL57226K



JL57123



JL57124



JL57238

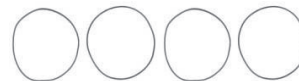

JL57671



JL57239

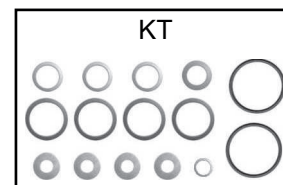

KT

Código/Code	N° Original	Aplicação / application	MP	C	K	M
57308		Cabeçote / cylinder head gasket	PAK	1	1	
57308MLS		Cabeçote / cylinder head gasket	MLS			1
57226		Tampa de válvulas / rocker cover gasket	BO	1	1	1
57050		Termostato / thermostat	NA	2	2	
57226K		Kit tampa de válvulas / rocker cover set	KT			
57123		Coletor de escapamento / exhaust manifold	CNAC	2	2	2
57124		Saída de escapamento / exhaust manifold	CNAC	1	1	1
57238		Guarnição	PP	2		2
57671		Anel das camisas	SI	4	4	4
57239		Válvula termostática / thermostatic valve	BO	1		1
KT		Kit de borrachas e arruelas / rubbers and washers		1	1	1
R950004		Kit de retentores para motor completo				
R921001	7581344	Retentores de haste de válvulas	VI	8	8	8
R954002	2101-1107015	Retentor do comando de válvulas 36x50x7	SI	1	1	1
R953002	51474	Retentor traseiro do virabrequim 85x105x12	SI	1		1
R954003	51472	Retentor dianteiro do virabrequim 42x66x6	SI	1		1

Itens Relacionados

Juntas para  
Cárter

Juntas para  
Injeção Eletrônica

Juntas para  
Injeção Eletrônica

Juntas para  
Filtro de Óleo

Juntas para  
Filtro de Óleo

JLSIL001  
Junta Líquida Cinza de Silicone para Altas Temperaturas 85G

JL15550  
Jogo de juntas para I.E. Peugeot 405/206 Singlepoint

JL15551  
Jogo de juntas para I.E. Peugeot 205 X SI 1.4 Singlepoint

JL57153  
Kit Borracha Base Filtro Óleo Peugeot 207/307/308 Motor 1.4/ 1.6

JL57154  
Kit Borracha Base Óleo Peugeot 206/207 Citroën C3/ Picasso Motor 1.4/ 1.6 16V 2006

R950004  
R921001 R954002  
R953002 R954003



Motor/Engine 1.6 16V TU5JP4(NFU/N6A)

Códigos jogos de juntas  
Code set gaskets

Modelo / Model	Cm³	De	Até	Completo com retentores <b>57108CR</b>	Full set with oil seals <b>57108CR</b>
206	1587	2000		Completo sem retentores <b>57108C</b>	Full set without oil seals <b>57108C</b>
Partner	1587	2000		Completo MLS com retentores <b>57108CMR</b>	Full set MLS with oil seals <b>57108CMR</b>
307	1587	2001		Completo MLS sem retentores <b>57108CM</b>	Full set MLS without oil seals <b>57108CM</b>
1007	1587	2004		Kit retificação com retentores <b>57108KR</b>	Head set with oil seals <b>57108KR</b>
Berlingo	1587	2000		Kit retificação sem retentores <b>57108K</b>	Head set without oil seals <b>57108K</b>
Xsara	1587	2000		Kit retificação MLS com retentores <b>57108KMR</b>	MLS Head set with oil seals <b>57108KMR</b>
C3	1587	2002		Kit retificação MLS sem retentores <b>57108KM</b>	MLS head set without oil seals <b>57108KM</b>
C2	1587	2003			
C3 Pluriel	1587	2003			
C4	1587	2004			

Código/Code	Nº Original	Aplicação / application	MP	C	K	M
57108	0209.1E	Cabeçote / cylinder head gasket	PAK	1	1	
57108MLS	0209.1E	Cabeçote / cylinder head gasket	MLS			1
57926	0249.A9	Tampa de válvulas / rocker cover gasket	BO	2	2	2
46522	0348.95	Coletor de admissão / intake manifold	BO	4	4	4
57223	0341.G2	Coletor de escapamento / exhaust manifold	CNAC	1	1	1
57518	0304.C5	Cárter / oil pan	BO	1		1
57816		Cárter / oil pan	NA	1		1
57224		Saída de escapamento	CNAC	1	1	1
57236		Carcaça válvula termostática	BO	1	1	1
57235	0127.40	Bastão traseiro do virabrequim	BO	2		2
KB		Kit de anéis de vedação	BO	1	1	1
R950006		Kit de retentores para motor completo				
R911002		Retentores de haste de válvulas	VI	16	16	16
R954004		Retentor do comando de válvulas 38x50x6	SI	2	2	2
R953002	51474	Retentor traseiro do virabrequim 85x105x12	SI	1		1
R954003	51472	Retentor dianteiro do virabrequim 42x66x6	SI	1		1

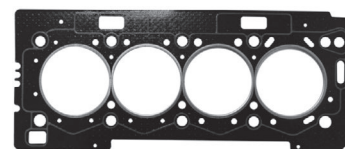

JL57108

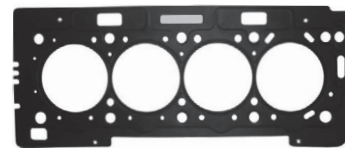

JL57108MLS



JL57926



JL46522



JL57223

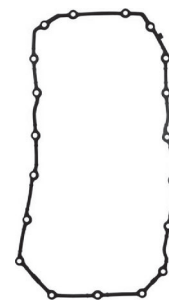

JL57518

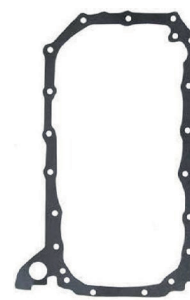

JL57816



JL57224



JL57236



JL57235

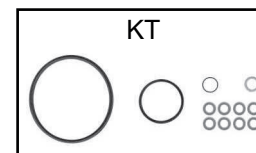

R950006



R911002



R954004



R953002



R954003

**Itens Relacionados**

Juntas para Injeção Eletrônica

Juntas para Injeção Eletrônica

Juntas para Filtro de Óleo

Juntas para Filtro de Óleo

JL15550  
Jogo de juntas para I.E. Peugeot 405/206 Singlepoint

JL15551  
Jogo de juntas para I.E. Peugeot 205 X SI 1.4 Singlepoint

JL57153  
Kit Borracha Base Filtro Óleo Peugeot 207/307/308 Motor 1.4/ 1.6

JL57154  
Kit Borracha Base Óleo Peugeot 206/207 Citroën C3/ Picasso Motor 1.4/ 1.6 16V 2006

Em breve novidades



Motor/Engine 1.6 16V TU5JP4(NFU/N6A)

Códigos jogos de juntas  
Code set gaskets

**Com junta TV de Nylon**

Modelo / Model	Cm³	De	Até
206	1587	2000	
Partner	1587	2000	
307	1587	2001	
1007	1587	2004	
Berlingo	1587	2000	
Xsara	1587	2000	
C3	1587	2002	
C2	1587	2003	
C3 Pluriel	1587	2003	
C4	1587	2004	

Completo com retentores  
**57901CR**  
Completo sem retentores  
**57901C**  
Completo MLS com retentores  
**57901CMR**  
Completo MLS sem retentores  
**57901CM**  
Kit retificação com retentores  
**57901KR**  
Kit retificação sem retentores  
**57901K**  
Kit retificação MLS com retentores  
**57901KMR**  
Kit retificação MLS sem retentores  
**57901KM**

Full set with oil seals  
**57901CR**  
Full set without oil seals  
**57901C**  
Full set MLS with oil seals  
**57901CMR**  
Full set MLS without oil seals  
**57901CM**  
Head set with oil seals  
**57901KR**  
Head set without oil seals  
**57901K**  
MLS Head set with oil seals  
**57901KMR**  
MLS Head set without oil seals  
**57901KM**

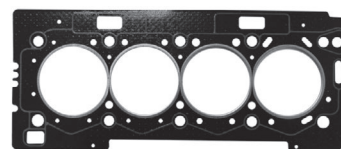

JL57108

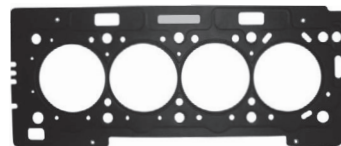

JL57108MLS



JL57927NY



JL46522



JL57223



JL57816



JL57224



JL57236



JL57235

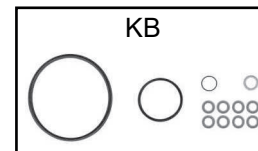

KB

Código/Code	Nº Original	Aplicação / Application	MP	C	K	M
57108	0209.1E	Cabeçote / Cylinder Head Gasket	PAK	1	1	
57108MLS	0209.1E	Cabeçote / Cylinder Head Gasket	MLS			1
57927NY	0249.A9	Tampa De Válvulas / Rocker Cover Gasket	NY	2	2	2
46522	0348.95	Coletor De Admissão / Intake Manifold	BO	4	4	4
57223	0341.G2	Coletor De Escapamento / Exhaust Manifold	CNAC	1	1	1
57816		Cárter / oil pan	NA	1	1	1
57224		Saída de escapamento	CNAC	1	1	1
57236		Carcaça válvula termostática	BO	1	1	1
57235	0127.40	Bastão Traseiro Do Virabrequim	BO	2	2	2
KB		Kit de borrachas / kit rubbers	KIT	1	1	1
R950006		Kit de retentores para motor completo				
R911002		Retentores De Haste De Válvulas	VI	16	16	16
R954004		Retentor Do Comando De Válvulas 38X50x6	SI	2	2	2
R953002	51474	Retentor Traseiro Do Virabrequim 85X105x12	SI	1		1
R954003	51472	Retentor Dianteiro Do Virabrequim 42X66x6	SI	1		1

**Itens Relacionados**

Juntas para Injeção Eletrônica

Juntas para Injeção Eletrônica

JL15550  
Jogo de juntas para I.E. Peugeot 405/206 Singlepoint

JL15551  
Jogo de juntas para I.E. Peugeot 205 X SI 1.4 Singlepoint

Em breve novidades

Em breve novidades

Em breve novidades

R950006

R911002 R954004  
R953002 R954003





Motor/Engine 1.6 16V THP

Códigos jogos de juntas  
Code set gaskets

Modelo / Model	Cm³	De	Até	Completo com retentores <b>57106CR</b>	Full set with oil seals <b>57106CR</b>
206	1587	2000		Completo sem retentores <b>57106C</b>	Full set without oil seals <b>57106C</b>
Partner	1587	2000		Completo MLS com retentores <b>57106CMR</b>	Full set MLS with oil seals <b>57106CMR</b>
307	1587	2001		Completo MLS sem retentores <b>57106CM</b>	Full set MLS without oil seals <b>57106CM</b>
1007	1587	2004		Kit retificação com retentores <b>57106KR</b>	Head set with oil seals <b>57106KR</b>
Berlingo	1587	2000		Kit retificação sem retentores <b>57106K</b>	Head set without oil seals <b>57106K</b>
Xsara	1587	2000		Kit retificação MLS com retentores <b>57106KMR</b>	MLS Head set with oil seals <b>57106KMR</b>
C3	1587	2002		Kit retificação MLS sem retentores <b>57106KM</b>	MLS head set without oil seals <b>57106KM</b>
C2	1587	2003			
C3 Pluriel	1587	2003			
C4	1587	2004			

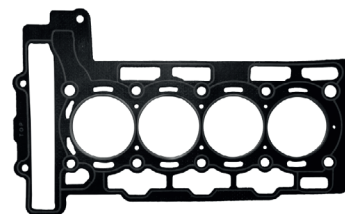

JL57106

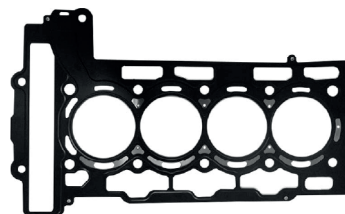

JL57106MLS

Código/Code	Nº Original	Aplicação / application	MP	C	K	M
57106		Cabeçote / cylinder head gasket	PAK	1	1	
57106MLS		Cabeçote / cylinder head gasket	MLS			1
57327		Tampa de válvulas / rocker cover gasket	BO			
57327B		Sobretampa de válvulas	BO			
57327K		Kit tampa e sobretampa de válvulas	KIT	1	1	1
57328K*		Kit diafragma	BO			
57327KD*		Kit tampa de válvulas e diafragma	KIT			
57933K		Coletor de admissão / intake manifold	KIT	1	1	1
57934MLS		Coletor de escapamento / exhaust manifold	MLS	1	1	1
57939		Saída de escapamento	CNAC	1	1	1
57936		Termostato / thermostat	BO	1	1	1
57058		Bomba d'água / water pump	BO	1	1	1
57931K		Kit filtro de óleo / oil filter set	KIT			
02804		Anel vedação filtro de óleo	BO	1		1
57931B		Filtro de óleo / oil filter	BO	1		1
57931C		Filtro de óleo / oil filter	BO	1		1
57961K		Kit suporte do filtro de óleo	KIT			
57961A		Suporte do filtro de óleo	BO	1		1
57961B		Suporte do filtro de óleo	BO	1		1
57961C		Suporte do filtro de óleo	BO	1		1
57961D		Suporte do filtro de óleo	BO	1		1
57960K		Kit completo suporte e filtro de óleo	KIT			
R950011		Kit de retentores para motor completo				
R951006		Retentores de haste de válvulas	VI	16	16	16
R963005		Retentor traseiro do virabrequim 85x105x8	SI	1		1
R954007		Retentor dianteiro do virabrequim 61x75x8	SI	1		1

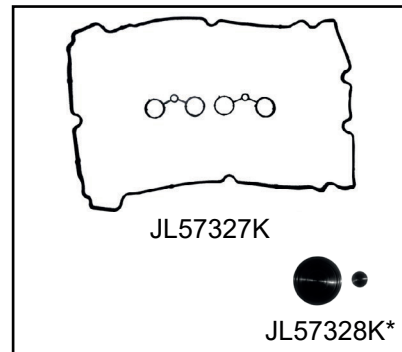

JL57327K

JL57328K\*

JL57327KD\*



JL57933K



JL57934MLS



JL57939



JL57936



JL57058



JL57931K

JL02804

JL57931B

JL57931C



JL57961K

JL57961A

JL57961B

JL57961C

JL57961D

JL57960K

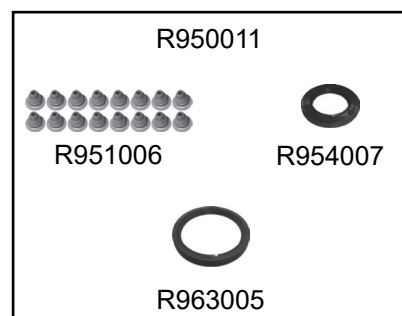

R950011

R951006

R954007

R963005

\*Não acompanha o jogo.  
Vendido separadamente.



Juntalima  
Indústria e Comércio de Auto Peças Ltda

- Juntas mls
- Juntas Metal-Elastômeto
- Juntas em Borracha
- Cortiças
- Retentores

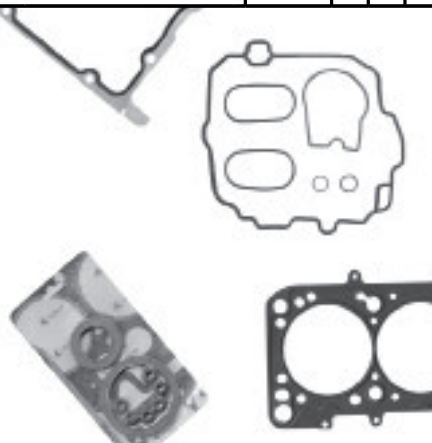



Motor/Engine 1.8 8V XU7JP  
1.8 8V XU7JB(LFX)

Códigos jogos de juntas  
Code set gaskets

Modelo / Model	Cm³	De	Até
405	1761	1992	1997
405	1761	1993	
306	1761	1992	
406	1761	1997	
Xantia	1761	1997	
Xsara	1761	1997	

Completo com retentores  
**57100CR**  
Completo sem retentores  
**57100C**  
Kit retificação com retentores  
**57100KR**  
Kit retificação sem retentores  
**57100K**

Full set with oil seals  
**57100CR**  
Full set without oil seals  
**57100C**  
Head set with oil seals  
**57100KR**  
Head set without oil seals  
**57100K**

Código/Code	N° Original	Aplicação / application	MP	C	K	M
57207	21011003020	Cabeçote / cylinder head gasket	PAK	1	1	1
57626	21011003270	Tampa de válvulas / rocker cover gasket	BO	1	1	
57617	21051002064	Coletor de admissão / intake manifold	SI	2	2	
57017	0348 F60	Coletor de admissão / intake manifold	SI	2	2	
57622		Coletor de escapamento / exhaust manifold	BO	4	4	
57522		Coletor de escapamento / exhaust manifold	PAK	4	4	
57222	1723630	Coletor de escapamento / exhaust manifold	PAK	1	1	
57221	21011002064	Coletor de escapamento / exhaust manifold	CNAC	4	4	
57215	21011003070	Cárter / oil pan	NA	1		
57334*		Gaxeta do escapamento	CNAC	1		
57270		Camisa do cilindro	SI	4	4	
57214	21011307046	Bomba d'água / water pump	NA	1	1	
57232	21011008081	Tampa de termostato	CB	1		
57235	21081107990	Bastão traseiro do virabrequim	BO	1		
57245	21011005155	Guarnição termostato	BO	1		
57430	0365.260	Anel do corpo de borboleta	BO	1		
KA		Kit de arruelas / kit washers	KA	1	1	
R950001		Kit de retentores para motor completo				
R921003	7581344	Retentores de haste de válvulas	VI	8	8	
R954002	2101-1107015	Retentor do comando de válvulas 36x50x7	SI	1	1	
R953001	011906/012728	Retentor traseiro do virabrequim 90x110x7	SI	1		
R954001	32622	Retentor dianteiro do virabrequim 42x62x7	SI	1		

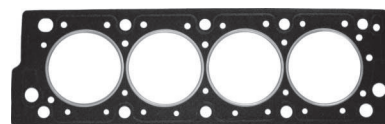

JL57207



JL57626



JL57617



JL57017



JL57622



JL57522



JL57222



JL57221



JL57215



JL57270



JL57334\*



JL57214



JL57232



JL57430



JL57235



JL57245

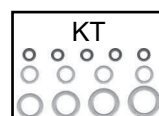

Itens Relacionados

Juntas para Injeção Eletrônica

Juntas para Injeção Eletrônica

Retentores

Retentores

Em breve novidades

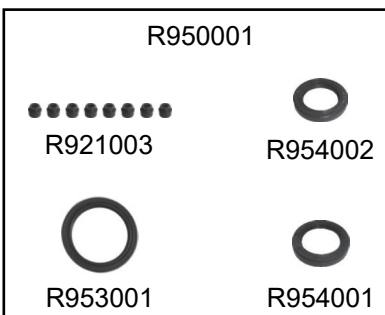

\*Não Acompanha o jogo. Vendido separadamente.



Motor/Engine 1.8 16V XU7JP4 (DOHC)

Códigos jogos de juntas  
Code set gaskets

Modelo / Model	Cm³	De	Até	Completo com retentores <b>57800CR</b>	Full set with oil seals <b>57800CR</b>
306	1761	1997		Completo sem retentores <b>57800C</b>	Full set without oil seals <b>57800C</b>
406	1761	1995		Kit retificação com retentores <b>57800KR</b>	Head set with oil seals <b>57800KR</b>
Xantia	1761	1995		Kit retificação sem retentores <b>57800K</b>	Head set without oil seals <b>57800K</b>
Xsara	1761	1997			
ZX	1761	1997			

Código/Code	Nº Original	Aplicação / application	MP	C	K	M
57807		Cabeçote / cylinder head gasket	PAK	1	1	
57126		Tampa de válvulas / rocker cover gasket	BO	2	2	
57227		Coletor de admissão / intake manifold	NA	1	1	
57822	0348.K6	Coletor de admissão / intake manifold	SI	4	4	
57225		Coletor de escapamento / exhaust manifold	PAK	1	1	
57229		Coletor de escapamento / exhaust manifold	CNAC	1	1	
57215	1723630	Cárter / oil pan	NA	1		
57270		Camisas dos cilindros	SI	4	4	
57214	21011307046	Bomba d'água / water pump	NA	1		
57833		Alojamento do termostato	NA	1		
57232	21011008081	Tampa de termostato	CB	1		
57235	21081107990	Bastão traseiro do virabrequim	BO	1		
57246		Guarnição termostato	BO	1		
57237		Tampa de óleo / oil cap	BO	1		
KA		Kit de arruelas / kit washers	KA	1	1	
R950002		Kit de retentores para motor completo				
R951003	0956.45	Retentores de haste de válvulas 6x10x17,5	VI	16	16	
R954002	2101-1107015	Retentor do comando de válvulas 36x50x8	SI	2	2	
R953001	011906/012728	Retentor traseiro do virabrequim 90x110x7	SI	1		
R954001	32622	Retentor dianteiro do virabrequim 42x62x7	SI	1		

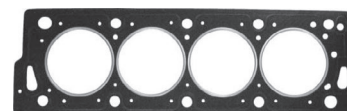

JL57807

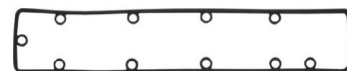
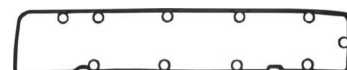

JL57126



JL57227



JL57822



JL57225



JL57229



JL57215



JL57270



JL57232



JL57214 JL57833 JL57232



JL57235 JL57246 JL57237

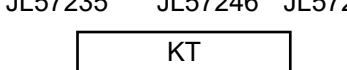

R950002 R951003 R954002 R953001 R954001

**Itens Relacionados**

Juntas para Injeção Eletrônica

Juntas para Injeção Eletrônica

Retentores

Retentores

JL15550  
Jogo de juntas para I.E. Peugeot 405/206 Singlepoint

JL15551  
Jogo de juntas para I.E. Peugeot 205 X SI 1.4 Singlepoint

R955001  
Retentor semi eixo diferencial maior saída esquerda Peugeot 1.8 16V XU7JP 40X58X11,3 mm

R955002  
Retentor semi eixo diferencial menor saída direita Peugeot 1.8 16V XU7JP 30X47X10 mm

Em breve novidades



Motor/Engine 2.0 16V EW10J4 (RFN/RLZ)

Códigos jogos de juntas  
Code set gaskets

Modelo / Model	Cm³	De	Até	Completo com retentores <b>57208CR</b>	Full set with oil seals <b>57208CR</b>
307 / 406 / 206	1997	2000		Completo sem retentores <b>57208C</b>	Full set without oil seals <b>57208C</b>
807 / 607 / 407	1997	2000		Completo MLS com retentores <b>57208CMR</b>	Full set MLS with oil seals <b>57208CMR</b>
Expert	1997	2004		Completo MLS sem retentores <b>57208CM</b>	Full set MLS without oil seals <b>57208CM</b>
Xsara	1997	2000		Kit retificação com retentores <b>57208KR</b>	Head set with oil seals <b>57208KR</b>
C5	1997	2000		Kit retificação sem retentores <b>57208K</b>	Head set without oil seals <b>57208K</b>
C8	1997	2001		Kit retificação MLS com retentores <b>57208KMR</b>	MLS Head set with oil seals <b>57208KMR</b>
C4	1997	2002		Kit retificação MLS sem retentores <b>57208KM</b>	MLS Head set without oil seals <b>57208KM</b>
Xsara Picasso	1997	2004			

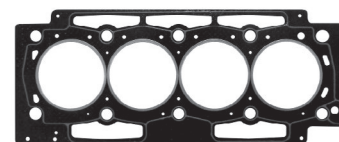

JL57208G

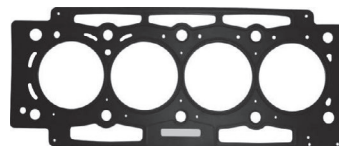

JL57208MLS

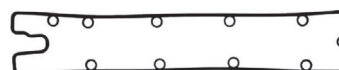

JL57826



JL57332



JL57331

JL57516



JL57316



JL57336

JL57338

JL57345



JL57333



JL57129



JL57048K

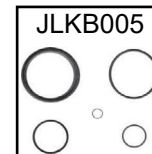

JLKB005

Código/Code	N° Original	Aplicação / application	MP	C	K	M
57208G	0209.Z3	Cabeçote / cylinder head gasket	PAK	1	1	
57208MLS	0209.Z3	Cabeçote / cylinder head gasket	MLS			1
57826	0249.A5/A4	Tampa de válvulas / rocker cover gasket	BO	2	2	2
57331	0348.P1	Coletor de admissão / intake manifold	NA	1		1
57516		Coletor de admissão / intake manifold	SI	4	4	4
57332	0349.H8	Coletor de escapamento / exhaust manifold	CNAC	1	1	1
57316		Cárter / oil pan	NA	1		1
57336		Tubulação da água	NA	1	1	1
57338		Base do suporte do óleo	NA	1		1
57345		Válvula termostática	NA	1	1	1
57333		Suporte do Filtro de óleo / oil filter	NA	1		1
57129	1206F6	Bomba d'água / water pump	BO	1		1
57048K		Kit radiador de óleo	KIT	1		1
KB005		Kit de borrachas/ kit rubbers	KB	1		1
R950007		Kit de retentores para motor completo				
R951003		Retentores de haste de válvulas 6x10x17,5	VI	16	16	16
R954002	2101-1107015	Retentor do comando de válvulas 36x50x7	SI	2	2	2
R953001	011906/012728	Retentor traseiro do virabrequim 90x110x7	SI	1		1
R924003	46434591/46780736	Retentor dianteiro do virabrequim 40x55x7	SI	1		1

Itens Relacionados

Juntas para Injeção Eletrônica

Juntas para Injeção Eletrônica

JL15550  
Jogo de juntas para I.E. Peugeot 405/206 Singlepoint

JL15551  
Jogo de juntas para I.E. Peugeot 205 X SI 1.4 Singlepoint

Em breve novidades

Em breve novidades

Em breve novidades

R950007

R951003 R954002

R953001 R924003



Motor/Engine 2.0 16V EW10A (RFJ)

Códigos jogos de juntas  
Code set gaskets

Modelo / Model	Cm³	De	Até	Completo com retentores <b>57103CR</b>	Full set with oil seals <b>57103CR</b>
C4	1997	2005		Completo sem retentores <b>57103C</b>	Full set without oil seals <b>57103C</b>
C4 Pallas	1997	2005		Completo MLS com retentores <b>57103CMR</b>	Full set MLS with oil seals <b>57103CMR</b>
Grand Picasso	1997	2006		Completo MLS sem retentores <b>57103CM</b>	Full set MLS without oil seals <b>57103CM</b>
307	1997	2005		Kit retificação com retentores <b>57103KR</b>	Head set with oil seals <b>57103KR</b>
407	1997	2005		Kit retificação sem retentores <b>57103K</b>	Head set without oil seals <b>57103K</b>
807	1997	2005		Kit retificação MLS com retentores <b>57103KMR</b>	MLS Head set with oil seals <b>57103KMR</b>
				Kit retificação MLS sem retentores <b>57103KM</b>	MLS Head set without oil seals <b>57103KM</b>

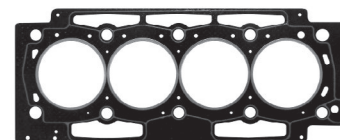

JL57208G

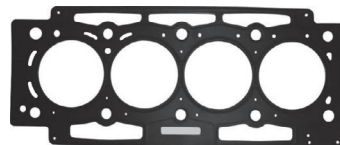

JL57208MLS



JL57423

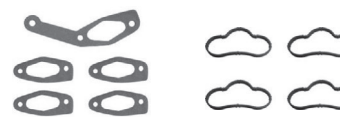

JL57331

JL57516

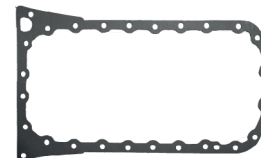

JL57316



JL57336

JL57338

JL57345



JL57333



JL57129

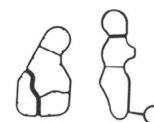

JL57048K

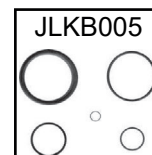

JLKB005

Código/Code	N° Original	Aplicação / application	MP	C	K	M
57208G	0209.Z3	Cabeçote / cylinder head gasket	PAK	1	1	
57208MLS	0209.Z3	Cabeçote / cylinder head gasket	MLS			1
57423	0349.H8	Coletor de escapamento / exhaust manifold	CNAC	1	1	1
57331	0348.P1	Coletor de admissão / intake manifold	NA	1		1
57516		Coletor de admissão / intake manifold	SI	4	4	4
57316		Cárter / oil pan	NA	1		1
57336		Tubulação de água	NA	1	1	1
57338		Base do suporte de óleo	NA	1		1
57345		Válvula termostática	NA	1	1	1
57333		Suporte do Filtro de óleo / oil filter	NA	1		1
57129	1206F6	Bomba d'água / water pump	BO	1		1
57048K		Kit radiador de óleo	KIT	1		1
KB005		Kit de borrachas / kit rubbers	KB	1		1
R950008		Kit de retentores para motor completo				
R951003		Retentores de haste de válvulas 6x10x17,5	VI	16	16	16
R954006		Retentor do comando de válvulas 39x50x7	SI	1	1	1
R954002	2101-1107015	Retentor do comando de válvulas 36x50x7	SI	1	1	1
R953001	011906/012728	Retentor traseiro do virabrequim 90x110x7	SI	1		1
R924003	46434591/46780736	Retentor dianteiro do virabrequim 40x55x7	SI	1		1

Itens Relacionados

Juntas para  
Cárter



Em breve novidades

Em breve novidades

Em breve novidades

Em breve novidades

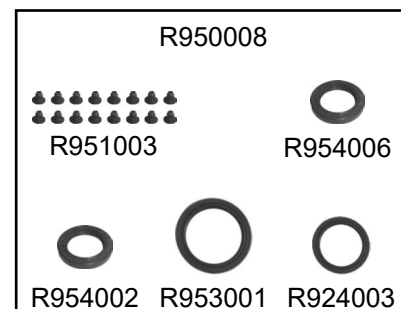



Motor/Engine 2.0 16V EW10A (RFJ)

Códigos jogos de juntas  
Code set gaskets

**Com junta TV de Nylon**

Modelo / Model	Cm²	De	Até
C4	1997	2005	
C4 Pallas	1997	2005	
C5	1997	2005	
C5 Tourer	1997	2008	
Grand Picasso	1997	2006	
307	1997	2005	
308 SW	1997	2008	
407	1997	2005	
807	1997	2005	

Completo com retentores <b>57105CR</b>	Full set with oil seals <b>57105CR</b>
Completo sem retentores <b>57105C</b>	Full set without oil seals <b>57105C</b>
Completo MLS com retentores <b>57105CMR</b>	Full set MLS with oil seals <b>57105CMR</b>
Completo MLS sem retentores <b>57105CM</b>	Full set MLS without oil seals <b>57105CM</b>
Kit retificação com retentores <b>57105KR</b>	Head set with oil seals <b>57105KR</b>
Kit retificação sem retentores <b>57105K</b>	Head set without oil seals <b>57105K</b>
Kit retificação MLS com retentores <b>57105KMR</b>	MLS Head set with oil seals <b>57105KMR</b>
Kit retificação MLS sem retentores <b>57105KM</b>	MLS Head set without oil seals <b>57105KM</b>

Código/Code	Nº Original	Aplicação / application	MP	C	K	M
57208G	0209.Z3	Cabeçote / cylinder head gasket	PAK	1	1	
57208MLS	0209.Z3	Cabeçote / cylinder head gasket	MLS			1
57937NY	0249H0	Kit Tampa de válvulas / rocker cover gasket	NY	1	1	1
57938*		Diafragma	BO			
57938NYD*		Kit tampa de válvulas com diafragma	KIT			
57423	0349.H8	Coletor de escapamento / exhaust manifold	CNAC	1	1	1
57331	0348.P1	Coletor de admissão / intake manifold	NA	1	1	1
57516		Coletor de admissão / intake manifold	SI	4	4	4
57316		Cárter / oil pan	NA	1	1	1
57333		Suporte do Filtro de óleo / oil filter	NA	1	1	1
57336		Tubulação de água		1	1	1
57338		Base do suporte de óleo	NA	1	1	1
57345		Válvula termostática	NA	1	1	1
57129	1206F6	Bomba d'água / water pump	BO	1	1	1
57048K		Kit radiador de óleo	KIT	1	1	1
KB005		Kit de borrachas / kit rubbers	KB	1	1	1
R950008		Kit de retentores para motor completo				
R951003		Retentores de haste de válvulas 6x10x17,5	VI	16	16	16
R954006		Retentor do comando de válvulas 39x50x7	SI	1	1	1
R954002	2101-1107015	Retentor do comando de válvulas 36x50x7	SI	1	1	1
R953001	011906/012728	Retentor traseiro do virabrequim 90x110x7	SI	1	1	1
R924003	46434591/46780736	Retentor dianteiro do virabrequim 40x55x7	SI	1	1	1

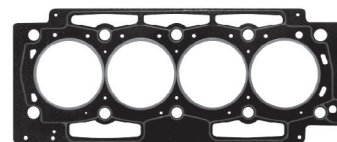

JL57208G

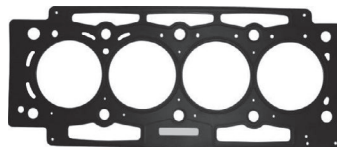

JL57208MLS

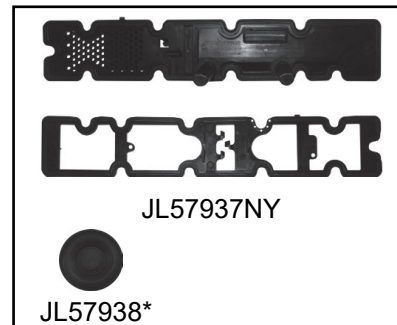

JL57937NY

JL57938\*

JL57937NYD\*



JL57423



JL57331

JL57516

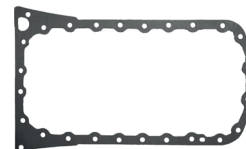

JL57316



JL57333

JL57336

JL57338

JL57345



JL57129

JL57048K

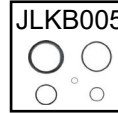

JLKB005

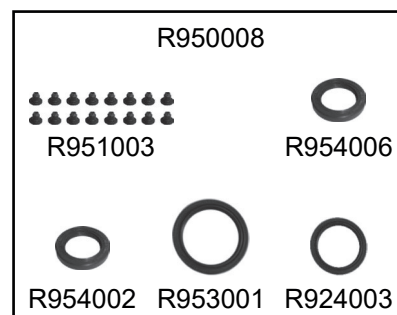

R950008

R951003

R954006

R954002

R953001

R924003

\*Não acompanha o jogo.  
Vendido separadamente.

**Juntalima**  
Indústria e Comércio de Auto Peças Ltda

**CONHEÇA NOSSA LINHA DE RETENTORES**



Motor/Engine 2.0 8V XU10J2C

Códigos jogos de juntas  
Code set gaskets

Modelo / Model	Cm³	De	Até	Completo com retentores <b>57600CR</b>	Full set with oil seals <b>57600CR</b>
405	1998	1992		Completo sem retentores <b>57600C</b>	Full set without oil seals <b>57600C</b>
306	1998	1993		Kit retificação com retentores <b>57600KR</b>	Head set with oil seals <b>57600KR</b>
Xantia	1998	1993		Kit retificação sem retentores <b>57600K</b>	Head set without oil seals <b>57600K</b>
ZX	1998	1992			

Código/Code	Nº Original	Aplicação / application	MP	C	K	M
57607	21011003020	Cabeçote / cylinder head gasket	PAK	1	1	
57626	21011003270	Tampa de válvulas / rocker cover gasket	BO	1	1	
57617	21051002064	Coletor de admissão / intake manifold	SI	2	2	
57417		Coletor de admissão / intake manifold	SI	2	2	
57222	1723630	Coletor de escapamento / exhaust manifold	PAK	1	1	
57522		Coletor de escapamento / exhaust manifold	PAK	4	4	
57221	21011002064	Coletor de escapamento / exhaust manifold	CNAC	4	4	
57215	21011003070	Cárter / oil pan	NA	1		
57334*		Gaxeta do escapamento	CNAC			
57270		Camisas do cilindro	SI	4	4	
57214	21011307046	Bomba d'água / water pump	NA	1		
57232	21011008081	Tampa do termostato	CB	1	1	
57235	21081107990	Bastão traseiro do virabrequim	BO	2		
57245	21011005155	Guarnição termostato	BO	1		
57430	0365.260	Anel do corpo da borboleta	BO	1		
KA		Kit de arruelas / kit washers	KA	1	1	
R950001		Kit de retentores para motor completo				
R921003	7581344	Retentores de haste de válvulas	VI	8	8	
R954002	2101-1107015	Retentor do comando de válvulas 36x50x8	SI	1	1	
R953001	012728	Retentor traseiro do virabrequim 90x110x7	SI	1		
R954001	32622	Retentor dianteiro do virabrequim 42x62x7	SI	1		



JL57607

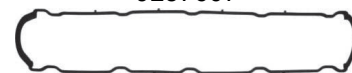

JL57626



JL57617



JL57417



JL57222



JL57522



JL57221



JL57215



JL57270



JL57214



JL57235



JL57232



JL57245



JL57430



JL57334\*

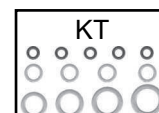

KT

Itens Relacionados

Juntas para Injeção Eletrônica

Juntas para Injeção Eletrônica

JL15550  
Jogo de juntas para I.E. Peugeot 405/206 Singlepoint

JL15551  
Jogo de juntas para I.E. Peugeot 205 X SI 1.4 Singlepoint

Em breve novidades

Em breve novidades

Em breve novidades

R950001

R921003 R954002  
R953001 R954001

\*Não Acompanha o jogo. Vendido separadamente.



Motor/Engine 2.0 16V XU10J4R(RFV)

Códigos jogos de juntas  
Code set gaskets

Modelo / Model	Cm³	De	Até	Completo com retentores <b>57607CR</b>	Full set with oil seals <b>57607CR</b>
306	1998	1995		Completo sem retentores <b>57607C</b>	Full set without oil seals <b>57607C</b>
406	1998	1995		Kit retificação com retentores <b>57607KR</b>	Head set with oil seals <b>57607KR</b>
605	1998	1995		Kit retificação sem retentores <b>57607K</b>	Head set without oil seals <b>57607K</b>
806	1998	1995			
Xantia	1998	1995	2001		
Xsara	1998	1998	2000		



JL57607

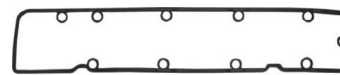

JL57126

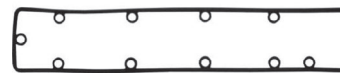

JL57227



JL57822



JL57225



JL57229



JL57215



JL57270



JL57214

JL57232

JL57833



JL57235



JL57246



JL57237

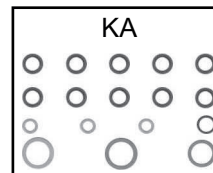

KA

Código/Code	N° Original	Aplicação / application	MP	C	K	M
57607		Cabeçote / cylinder head gasket	PAK	1	1	
57126		Tampa de válvulas / rocker cover gasket	BO	2	2	
57227		Coletor de admissão / intake manifold	NA	1	1	
57822	0348.K6	Coletor de admissão / intake manifold	SI	4	4	
57225		Coletor de escapamento / exhaust manifold	PAK	1	1	
57229		Coletor de escapamento / exhaust manifold	CNAC	1	1	
57215	1723630	Cárter / oil pan	NA	1		
57270		Camisas dos cilindros	SI	4	4	
57214	21011307046	Bomba d'água / water pump	NA	1		
57232	21011008081	Tampa de termostato	CB	1		
57833		Alojamento do termostato	NA	1		
57235	21081107990	Bastão traseiro do virabrequim	BO	1		
57246		Guarnição termostato	BO	1		
57237		Tampa de óleo / oil cap	BO	1		
KA		Kit de arruelas / kit washers	KA	1	1	
R950002		Kit de retentores para motor completo				
R951003	0956.45	Retentores de haste de válvulas 6x10x17,5	VI	16	16	
R954002	2101-1107015	Retentor do comando de válvulas 36x50x8	SI	2	2	
R953001	011906/012728	Retentor traseiro do virabrequim 90x110x7	SI	1		
R954001	32622	Retentor dianteiro do virabrequim 42x62x7	SI	1		

Itens Relacionados

Juntas para Injeção Eletrônica

Juntas para Injeção Eletrônica

JL15550  
Jogo de juntas para I.E. Peugeot 405/206 Singlepoint

JL15551  
Jogo de juntas para I.E. Peugeot 205 X SI 1.4 Singlepoint

Em breve novidades

Em breve novidades

Em breve novidades

R950002

R951003

R954002

R953001

R954001





Motor/Engine 2.3 8V Diesel			
XD2/2P/2S - XD3/3P/3T			
Modelo / Model	Cm³	De	Até
504 D	2304	1976	1993
505 TD	2304	1981	
J7 D	2304	1977	
604 TD	2304	1978	1983
505 D	2304	1979	1982
J9	2304	1980	

Códigos jogos de juntas Code set gaskets	
Completo com retentores <b>57405CR</b>	Full set with oil seals <b>57405CR</b>
Completo sem retentores <b>57405C</b>	Full set without oil seals <b>57405C</b>
Completo c/ retentores s/ cabeçote <b>57405SCR</b>	Full set w/o cyl. head gasket with oil seals <b>57405SCR</b>
Completo sem cabeçote <b>57405SC</b>	Full set without cyl. head gasket <b>57405SC</b>
Kit retificação com retentores <b>57405KR</b>	Head set with oil seals <b>57405KR</b>
Kit retificação sem retentores <b>57405K</b>	Head set without oil seals <b>57405K</b>
Kit sem cabeçote com retentores <b>57405KSCR</b>	Head set w/o head gasket with seals <b>57405KSCR</b>
Kit retificação sem cabeçote <b>57405KSC</b>	Retification kit without head gasket <b>57405KSC</b>

Código/Code	Nº Original	Aplicação / application	MP	C	K	M
016115-1MP		Cabeçote / cylinder head gasket (1.5 mm)	MPAK	1	1	
016115-2MP		Cabeçote / cylinder head gasket (1.6 mm)	MPAK			
016115-3MP		Cabeçote / cylinder head gasket (1.7 mm)	MPAK			
016727	0249250	Tampa de válvulas / rocker cover gasket	CB	1	1	
016411	039540	Coletor de escapamento / exhaust manifold	CNAC	2	2	
016412		Coletor de escapamento / exhaust manifold	CNAC	2	2	
016413		Coletor de escapamento / exhaust manifold	PAK	2	2	
016414		Coletor de admissão central / central intake manifold	GV	1	1	
016419		Coletor de admissão / intake manifold	GV	2	2	
016517	0313190	Cárter / oil pan	PAK	1		
016420		Saída do escapamento / exhaust pipe	CNAC	1		
016933	1710200	Saída do escapamento / exhaust pipe	CNAC	1		
016734	1710430	Coletor de escapamento a flange	CNAC	1		
57290		Anel da camisa do cilindro	SI	4	4	
016429	0321390	Tampa da distribuição / timing cover	GV	1		
016418		Base da bomba injetora	GV	1		
016631	1927070	Guarnição do termostato	GV	1	1	
016441		Contratampa da distribuição	GV	2		
016434		Tampa da Bomba d'água com continuação	GV	1		
016919	1206230	Bomba d'água / water pump	GV	1	1	
016435	1104130	Base do Filtro de óleo / oil filter	GV	1		
016439		Arruela da bomba injetora	GV	1		
016440	0236070	Tampa da câmara d'água	GV	2		
016430	0147100	Tampa dos injetores	GV	2		
016443	1041100	Bomba de óleo / oil pump ao bloco	GV	1		
70019	7073000617	Gaxeta do mancal traseiro	NAGR	2		
57235	0127050	Bastão traseiro do virabrequim	BO	2		
KA		Kit de arruelas / kit washers	AL	1	1	
R950005		Kit de retentores para motor completo	VI	8	8	
R921003		Retentores de haste de válvulas 8x11x10	SI	1		
R954005		Retentor dianteiro do virabrequim 45x60x10				

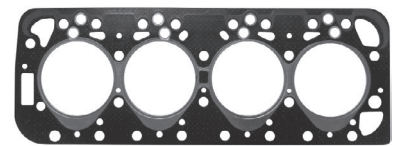

JL016115-1MP / JL016115-2MP  
JL016511-3MP

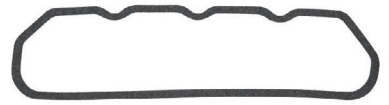

JL016727



JL016411 JL016412 JL016413



JL016414 JL016419

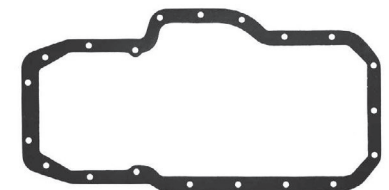

JL016517



JL016420 JL016933 JL016734

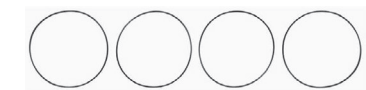

JL57290



JL016429 JL016418



JL016631 JL016441 JL016434



JL016919 JL016435 JL016439



JL016440 JL016430 JL016443



JL70019 JL57235

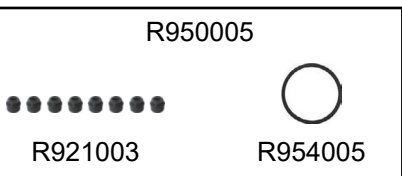

R950005

R921003 R954005



**Juntalima**  
Indústria e Comércio de Auto Peças Ltda

REFERÊNCIA NACIONAL  
EM JUNTAS MLS



Junta

Aplicação

Veículo / Motor

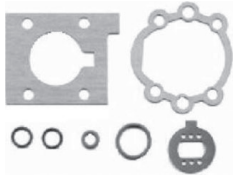

JL15550

Jogo de juntas para injeção eletrônica

405/106 singlepoint

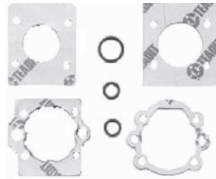

JL15551

Jogo de juntas para injeção eletrônica

205 X SI 1.4 singlepoint



Motor/Engine 1.0 16V D4D Hiflex

1.0 16V D4F Hiflex

Códigos jogos de juntas  
Code set gaskets

Modelo / Model Cm³ De Até

Logan	998		
Sandero	998		
206	999		
Clio III	1149		
Clio IV	1149		

Completo com retentores  
**57205CR**  
Completo sem retentores  
**57205C**  
Completo MLS com retentores  
**57205CMR**  
Completo MLS sem retentores  
**57205CM**  
Kit retificação com retentores  
**57205KR**  
Kit retificação sem retentores  
**57205K**  
Kit retificação MLS com retentores  
**57205KMR**  
Kit retificação MLS sem retentores  
**57205KM**

Full set with oil seals  
**57205CR**  
Full set without oil seals  
**57205C**  
Full set MLS with oil seals  
**57205CMR**  
Full set MLS without oil seals  
**57205CM**  
Head set with oil seals  
**57205KR**  
Head set without oil seals  
**57205K**  
MLS Head set with oil seals  
**57205KMR**  
MLS Head set without oil seals  
**57205KM**

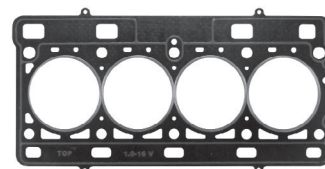

JL57306

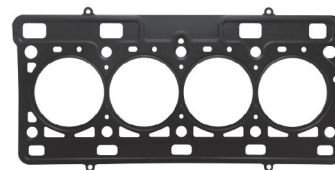

JL57306MLS

Código/Code	N° Original	Aplicação / application	MP	C	K	M
57306	820.004.9012	Cabeçote / cylinder head gasket	PAK	1	1	
57306MLS	820.004.9012	Cabeçote / cylinder head gasket	MLS			1
57025	770.010.6172	Tampa de válvulas / rocker cover gasket	BO	1	1	1
57036KV		Kit vedadores de velas	KIT	1	1	1
57025K		Kit tampa de válvulas e vedadores de velas	KIT			
57324MLS		Coletor de escapamento / exhaust manifold	MLS	1	1	1
57323	770.147.3007	Coletor de admissão / intake manifold	BO	4	4	4
57511	770.086.6465	Cárter / oil pan	CB	1		1
57313		Bomba d'água / water pump	NA	1	1	1
57149		Bomba de óleo / oil pump	PV	1	1	1
R960009		Kit de retentores para motor completo				
R961006	770103938	Retentores de haste de válvulas	VI	16	16	16
R964002	7701473495	Retentor do comando de válvulas 28x47x8	SI	1	1	1
R963001	770874223	Retentor traseiro do virabrequim 70x86x7	SI	1		1
R964001	770873534	Retentor dianteiro do virabrequim 32x44x6	SI	1		1

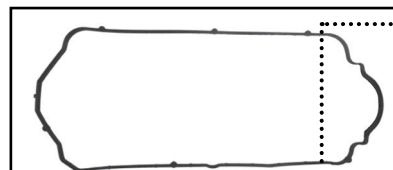

JL57025



JL57036KV

JL57025K



JL57324MLS



JL57323

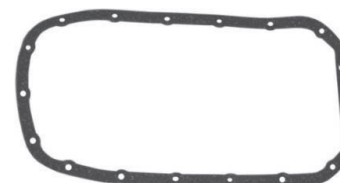

JL57511



JL57313



JL57149

Itens Relacionados

Juntas para Injeção Eletrônica

Juntas para Injeção Eletrônica

Juntas para Injeção Eletrônica

Juntas para Injeção Eletrônica

Selo do motor

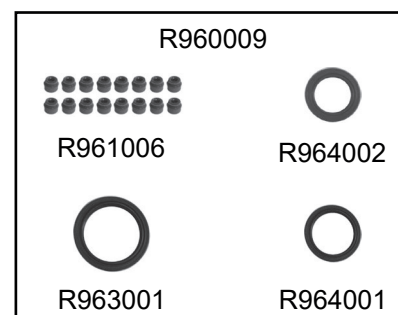
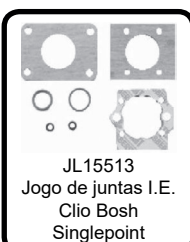



Motor/Engine 1.0 16V D4D (Todos)  
1.0 16V D4F (Todos)

Códigos jogos de juntas  
Code set gaskets

Modelo / Model Cm³ De Até

Peugeot 206	999	2000	
Clio II	1149	2001	
Kangoo	1149	2001	
Twingo	1149	2001	
Modus	1149	2001	

Completo com retentores <b>57505CR</b>	Full set with oil seals <b>57505CR</b>
Completo sem retentores <b>57505C</b>	Full set without oil seals <b>57505C</b>
Completo MLS com retentores <b>57505CMR</b>	Full set MLS with oil seals <b>57505CMR</b>
Completo MLS sem retentores <b>57505CM</b>	Full set MLS without oil seals <b>57505CM</b>
Kit retificação com retentores <b>57505KR</b>	Head set with oil seals <b>57505KR</b>
Kit retificação sem retentores <b>57505K</b>	Head set without oil seals <b>57505K</b>
Kit retificação MLS com retentores <b>57505KMR</b>	MLS Head set with oil seals <b>57505KMR</b>
Kit retificação MLS sem retentores <b>57505KM</b>	MLS Head set without oil seals <b>57505KM</b>

Código/Code	Nº Original	Aplicação / application	MP	C	K	M
57306	820.004.9012	Cabeçote / cylinder head gasket	PAK	1	1	
57306MLS	820.004.9012	Cabeçote / cylinder head gasket	MLS			1
57046		Sobre tampa de válvulas / rocker cover	BO	1	1	1
57036	770.104.9888	Tampa de válvulas / rocker cover gasket	BO	1	1	1
57036KV		Kit de vedadores de velas	KIT	1	1	1
57036K		Kit tampa de válvulas com vedadores de velas	KIT			
57046B*		Bucha do anel do respiro do óleo	BO			
57324MLS	820.008.7124	Coletor de escapamento / exhaust manifold	MLS	1	1	1
57323	770.147.3007	Coletor de admissão / intake manifold	BO	4	4	4
57511	770.086.6465	Cárter / oil pan	CB	1		1
57313		Bomba d'água / water pump	NA	1	1	1
57149		Bomba de óleo / oil pump	PV	1	1	1
R960003		Kit de retentores para motor completo				
R961002	7700103938	Retentores de haste de válvulas	VI	16	16	16
R964002	7701473495	Retentor do comando de válvulas 28x47x8	SI	1	1	1
R963001	7700874223	Retentor traseiro do virabrequim 70x86x7	SI	1		1
R964001	770873534	Retentor dianteiro do virabrequim 32x44x6	SI	1		1

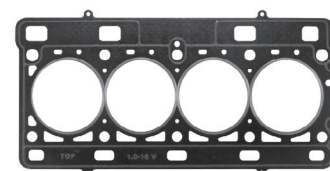

JL57306

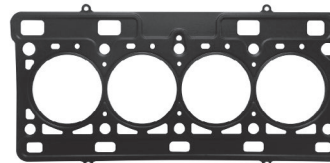

JL57306MLS



JL57046

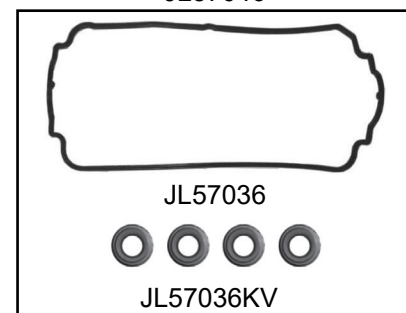

JL57036

JL57036KV

JL57036K



JL57046B\*



JL57324MLS



JL57323(x4)

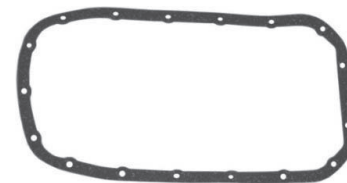

JL57511



JL57313



JL57149

Itens Relacionados

<p>Juntas para Injeção Eletrônica</p> <p>JL15511 Jogo juntas I.E. Mod. 19 singlepoint</p>	<p>Juntas para Injeção Eletrônica</p> <p>JL15512 Jogo de juntas I.E. Twingo Singlepoint</p>	<p>Juntas para Injeção Eletrônica</p> <p>JL15513 Jogo de juntas I.E. Clio Bosh Singlepoint</p>	<p>Juntas para Injeção Eletrônica</p> <p>JL15514 Jogo juntas I.E. Clio RN Multipoint</p>	<p>Selo do motor</p> <p>JL57838 Selo do comando de válvulas 47x7 Motor 1.0 16V D4F</p>
---	---	--	--	--

<p>R960003</p> <p>R961002</p> <p>R963001</p>	<p>R964002</p> <p>R964001</p>
--	-------------------------------

\*Não acompanha o jogo.  
Vendido separadamente.